



www.cliosoft.com

The DM of Choice

**Design Data Management for
Synopsys Custom Designer**

November 6, 2008

- ClioSoft design data management overview
- Challenges of managing design data
- DM support for Custom Designer

- Collaborate with team members and share design data regardless of geographical location & time zone
- Manage all design data from Docs to GDSII
- Control and audit access and actions
- Track changes and maintain revisions and releases
- Streamline design flow
- Tapeout accurately with confidence

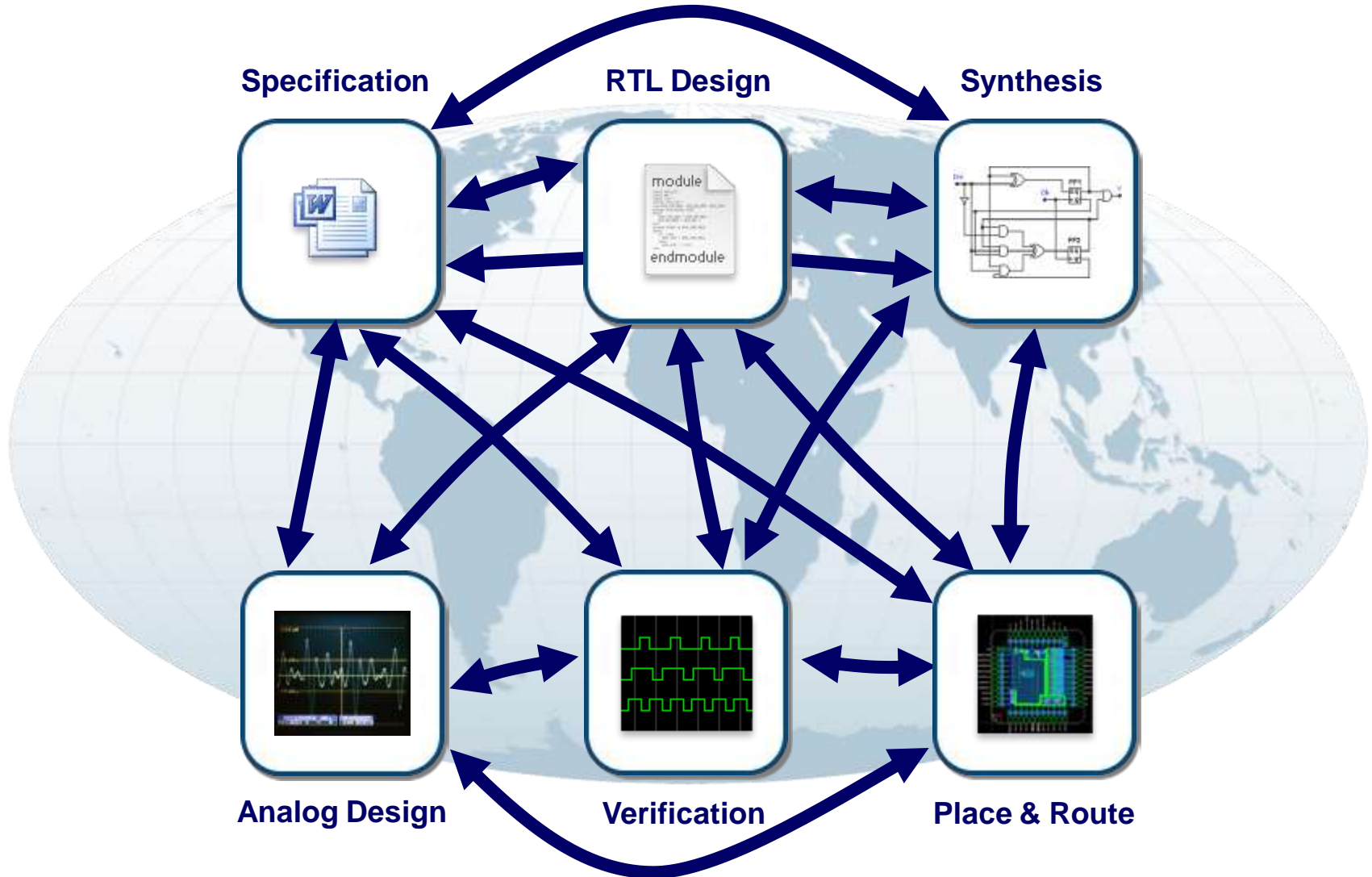

- Design errors
 - Require very expensive re-spin
- Project delays
 - Impact time to market
- Lack of control and visibility
 - Decreased predictability
- CAD support nightmare

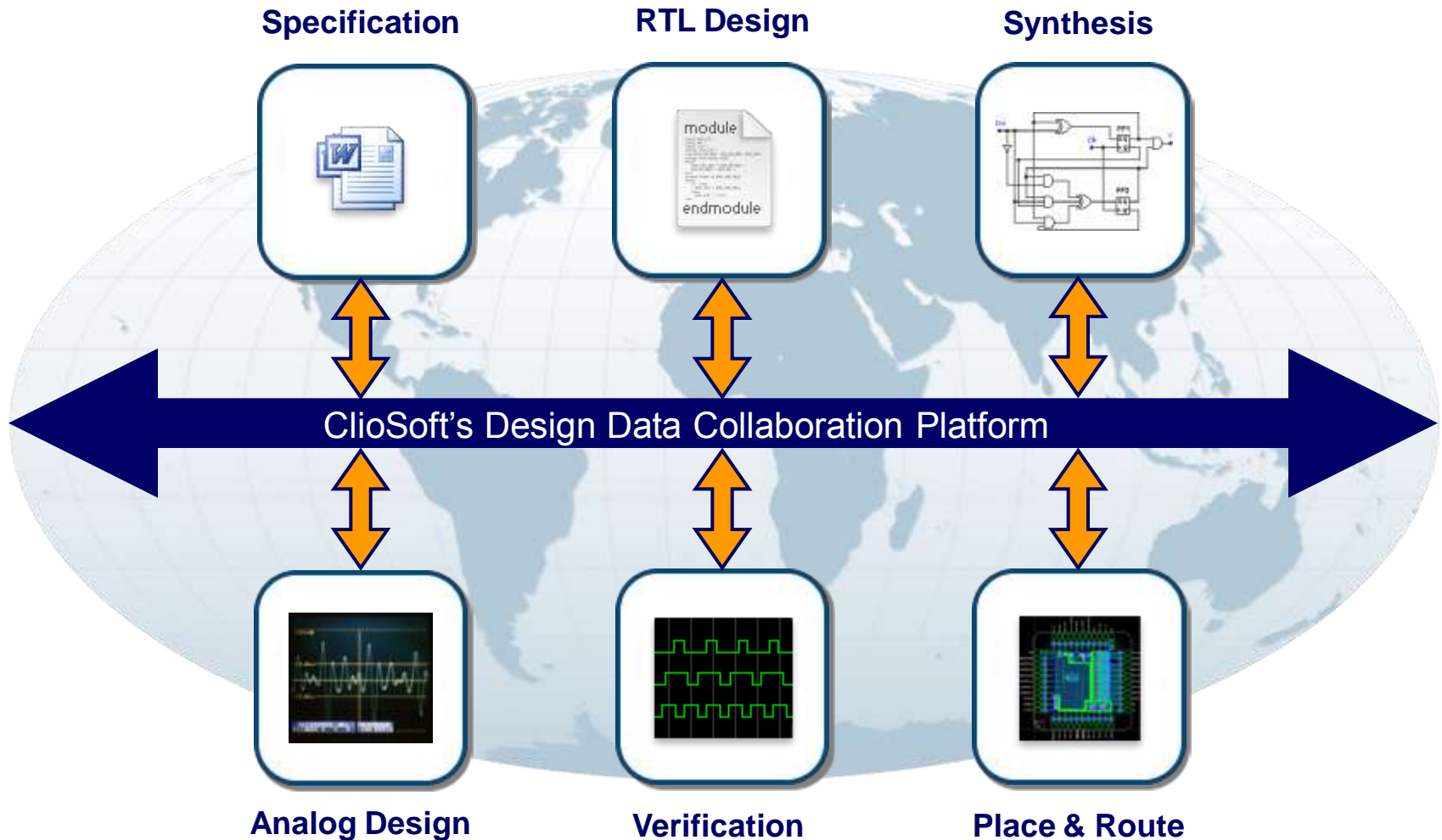

Design Aware Integrations

Authentication & Access Controls

Global Collaboration

Design Reuse

Integrated with Issue Tracking

Release & Derivative Management

Version Control for Files & Directories

- Design tools often create several files with program generated names
 - Examples: Schematic & Custom Layout editors
- Data for each design unit may be saved in several files
- Several temporary & run files are also created by the tools
 - Example: log, lock, backup
- End users cannot easily make sense of the design data
 - Which files should be managed & versioned
 - Which files belong together
 - Which files should NOT be managed
- Design operations affect DM
 - Open for edit, rename, copy, etc.

- Universal DM Adaptor
 - Recognize and manage OpenAccess libraries
 - Loose integration available now
- Custom DM Adaptor
 - Integrated DM GUI
 - Under development

- Configurable rules to recognize and organize design data
 - Recognize design libraries
 - Recognize design objects
 - Organize required design files into composite design objects
 - Exclude temporary files
 - Re-apply rules on check-in to recreate composite design object
- Soft integration with design tools

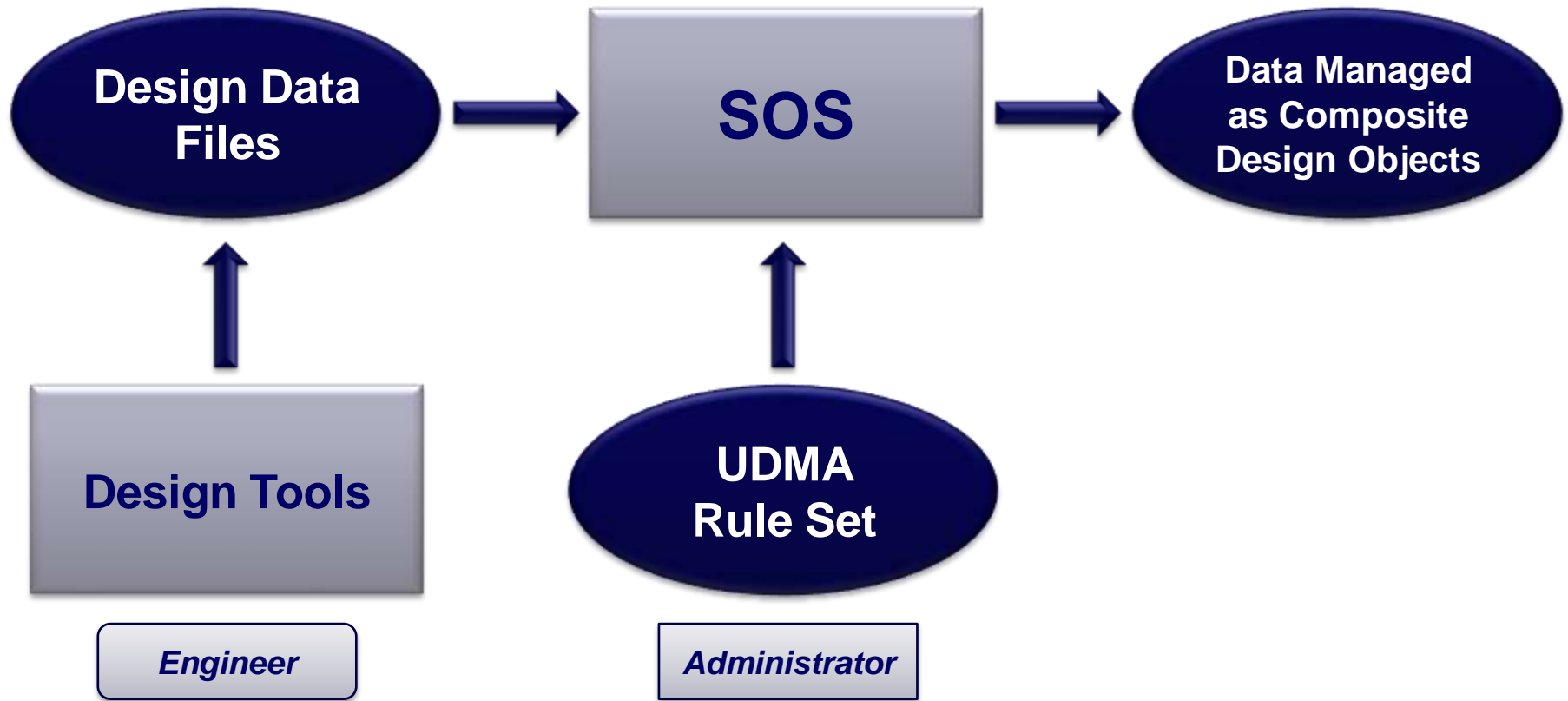

Files

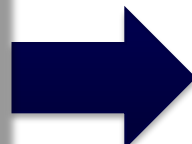
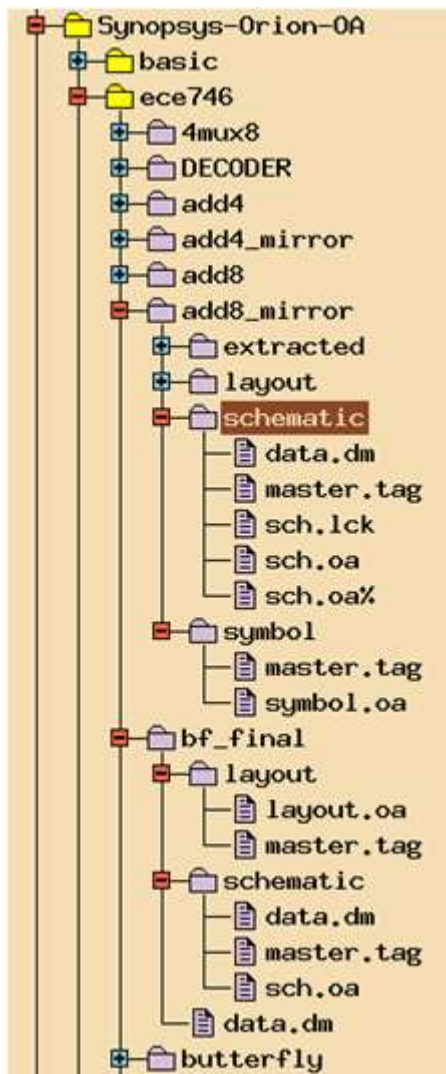

UDMA Rule

```

package
  CustomDesigner {

    libid matchany
      "**/data.dm";

    basename globany
      "{*}/master.tag",
      "{*}/*.oa";

    packname use "$1";

    include globplus
      "$1/*";

    exclude glob
      "**lck", "**%";

  }
    
```



Custom Designer Cell-Views

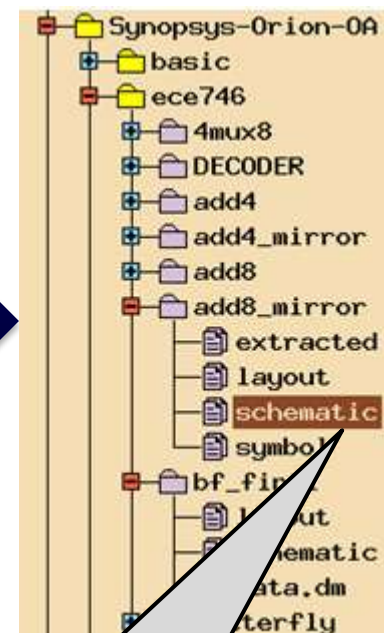

Collection of files automatically packaged as a composite object using the rule set

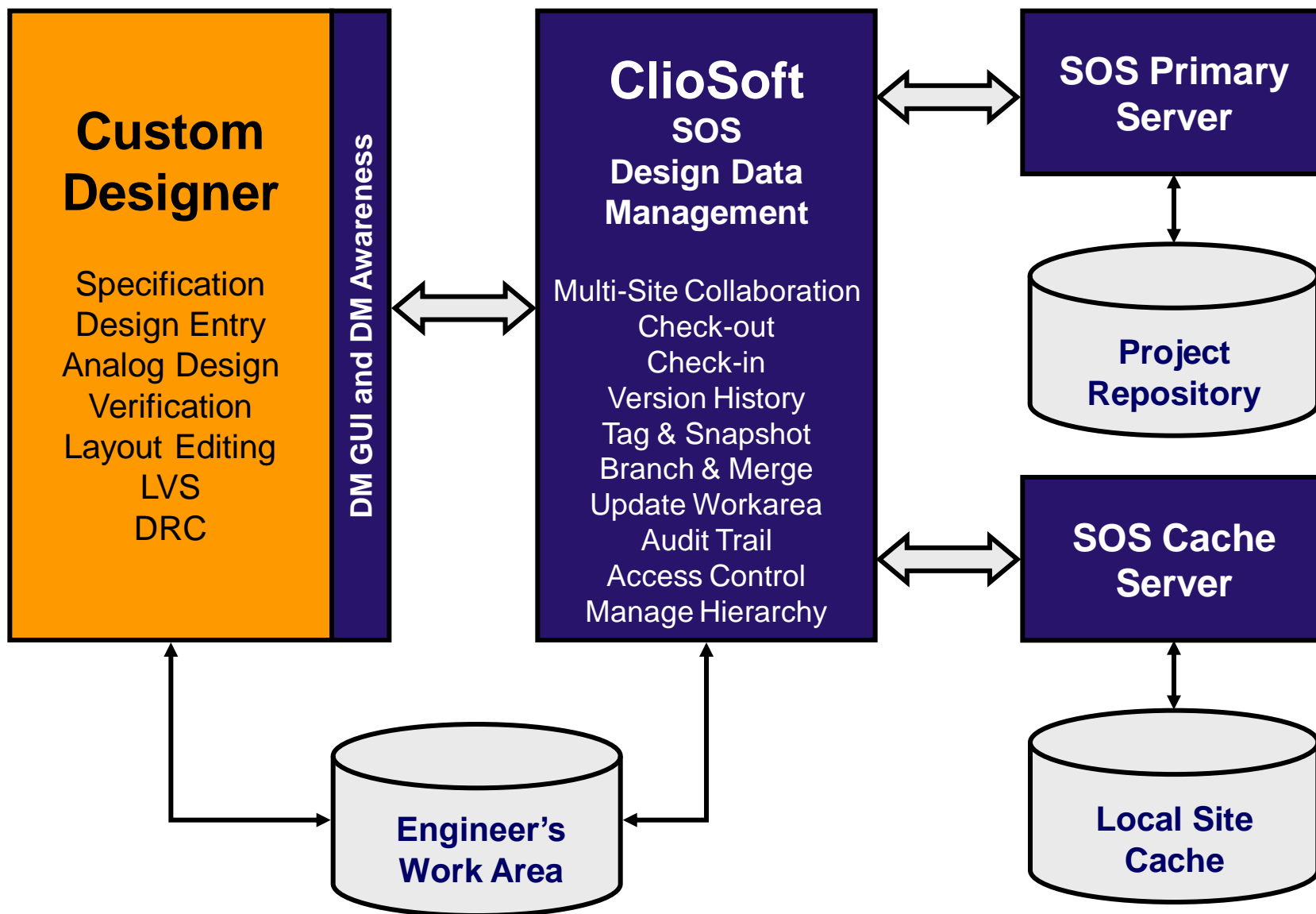

- Integrated data management GUI in library browser and editors
 - DM operations readily available
- Version control awareness in Custom Designer
 - Auto checkout & checkin for edit, delete, rename, copy
- ‘Design Aware’ version control features
 - Operate on design objects like libraries, cells and views and not files
 - Support for design hierarchies/categories

- Synopsys Custom Designer
 - Standard OpenAccess database
 - Published TCL API
 - **Query design libraries**
 - **Add custom menus**
 - Customizable GUI
 - **Standard Qt based platform independent GUI**
 - Support for version control plug-in
 - **Version control awareness for the entire flow**
- ClioSoft SOS
 - C API
 - Universal DM Adaptor
- Cooperation between Synopsys and ClioSoft